

SPINAL IMPLANTS – Test Methods

Internal fixators and plates

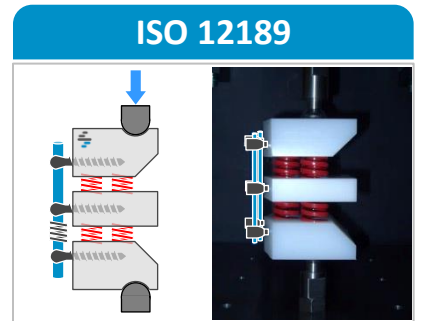

Cages and vertebral body replacements

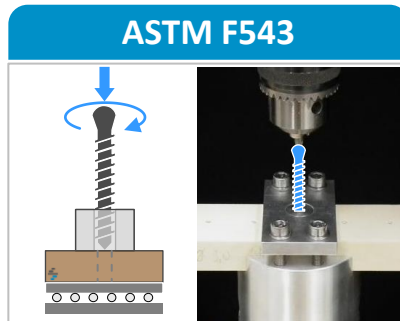
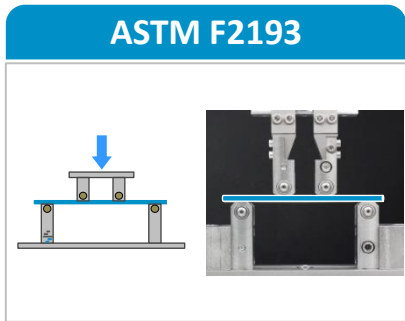
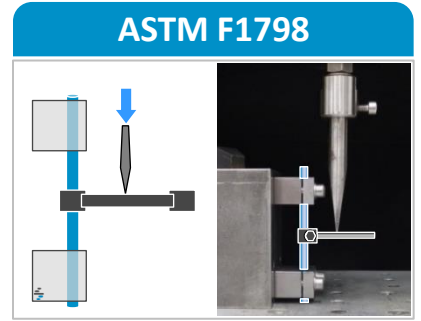
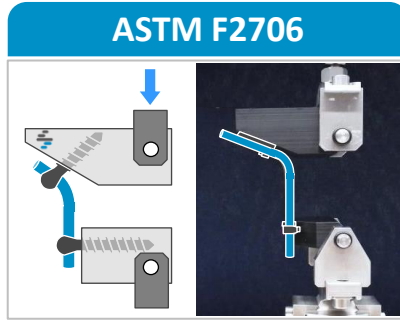
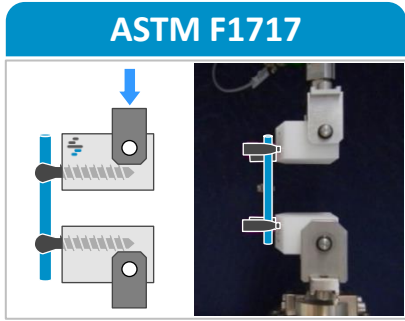
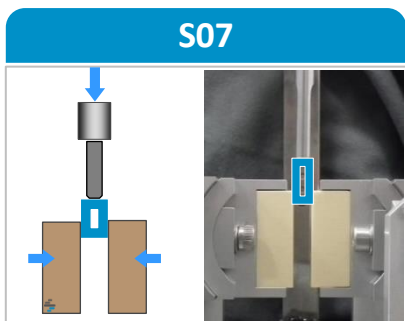
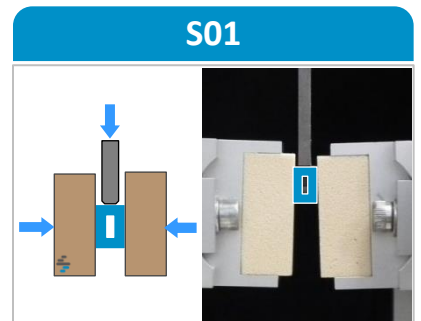
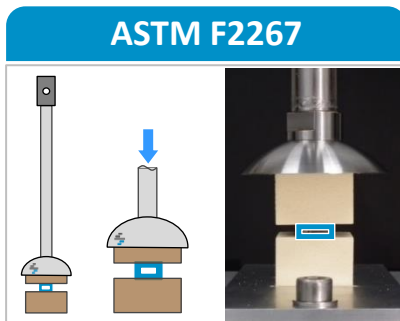

SPINAL IMPLANTS – Test Methods

Intervertebral disc prostheses

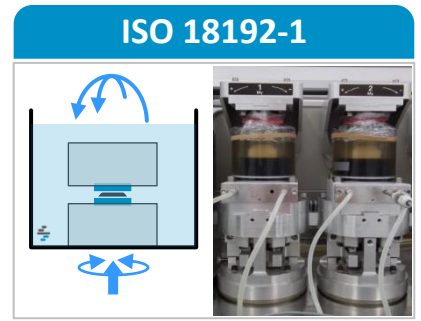
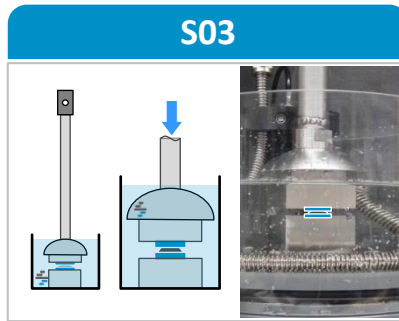
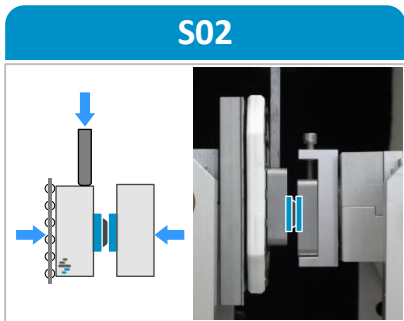
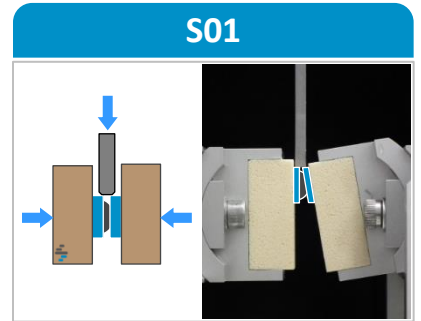
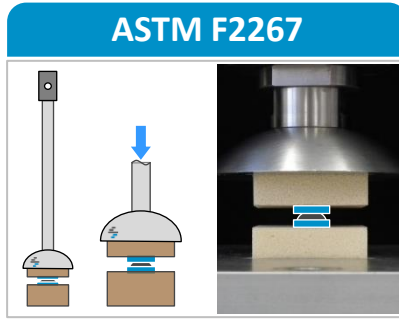
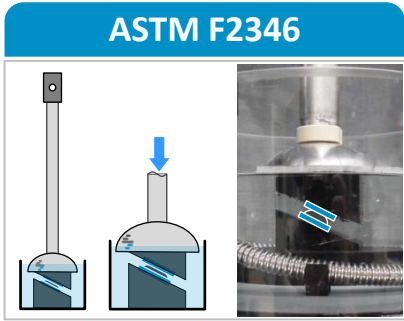

Extradiscal motion preserving implants

