

# HIP IMPLANTS – Test Methods

## Hip stem

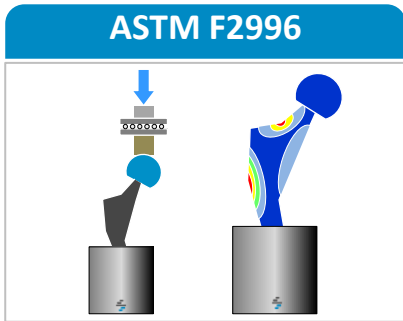

## Acetabular devices, cup and insert

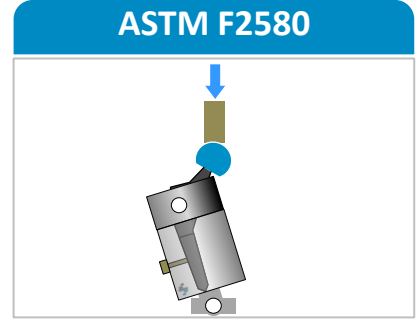
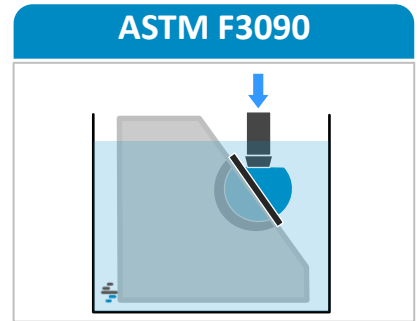
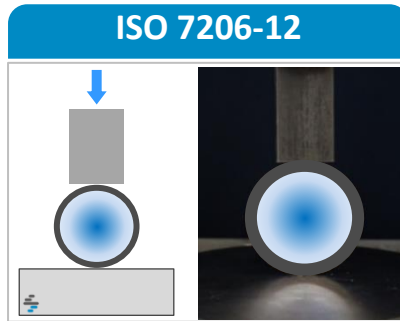
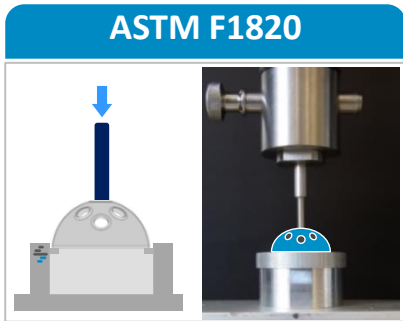

## Modular hip, cone-taper interface

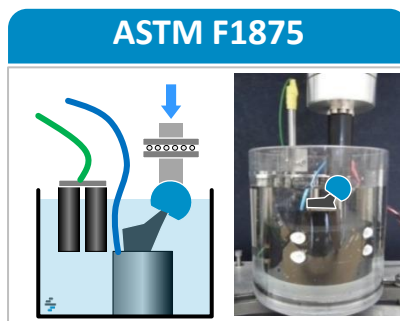
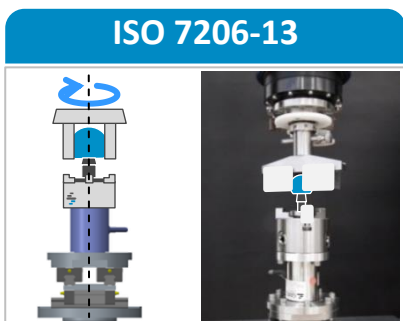

# HIP IMPLANTS – Test Methods

## Femoral head

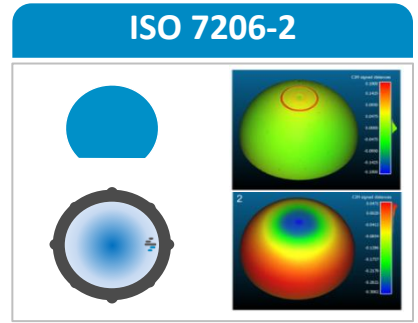
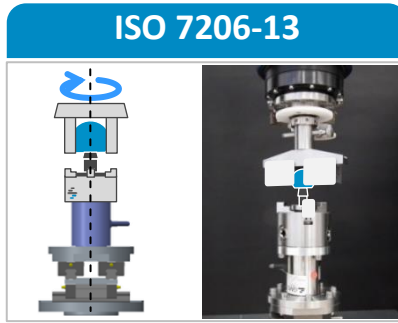
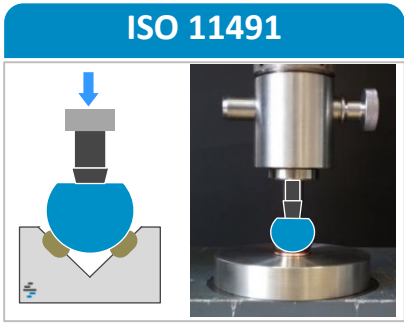
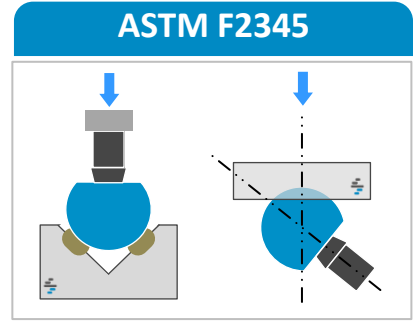
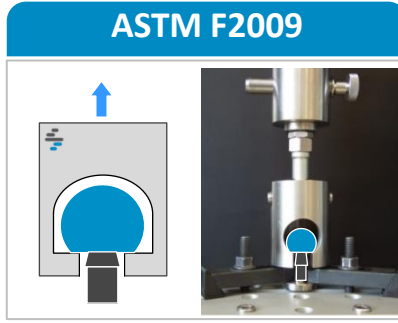
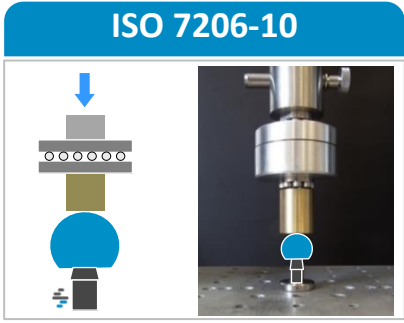

## Total hip replacement

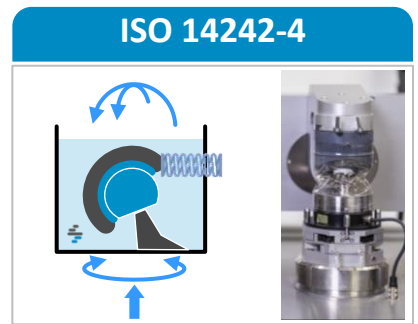
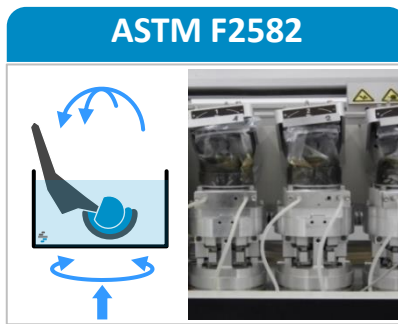
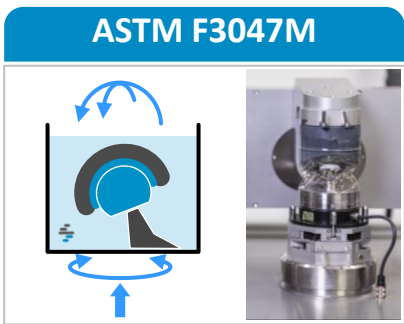
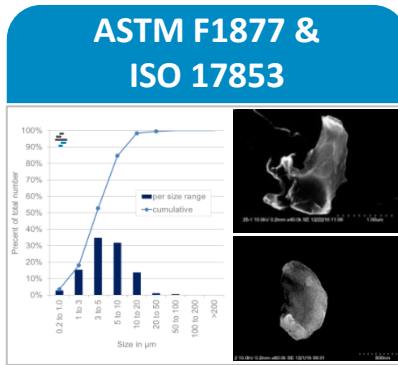

# HIP IMPLANTS – Test Methods

## Aging



## Calciumphosphate or metallic coatings

